

48 V Standalone Battery Module

Service Manual

About this manual

This manual describes how to service EM048063P3S and EM048126P3S series battery modules by LG Chem. Read this manual before you attempt to service the product. If you are uncertain about any of the requirements, recommendations, or safety procedures described in this manual, contact LG Chem immediately for advice and clarification.

The information included in this manual is accurate at the time of publication. However, the product specifications are subject to change without prior notice. In addition, the illustrations in this manual are meant to help explain system configuration concepts. The illustrated items may differ from the actual items at the installation location.

NOTE

The battery modules must communicate with its higher level system using the required communication protocol.























































Contents

1 Alerts by Status Indicators	4
1.1 Abnormal states	4
1.1.1 Fault 1 states	5
1.1.2 Fault 2 states	6
1.2 Voltage abnormality	7
1.2.1 Cell overvoltage	7
1.2.2 Cell undervoltage	7
1.2.3 Too low module voltage	7
1.2.4 Too large voltage difference between cells	8
1.3 Current abnormality	8
1.3.1 Over-charged current	8
1.3.2 Over-discharged current	8
1.3.3 Over-charged power	9
1.3.4 Over-discharged power	9
1.4 Temperature abnormality	10
1.4.1 Too high battery temperature	10
1.4.2 Too low battery temperature	10
1.4.3 Too large temperature difference inside battery module	10
1.5 Lost communication	11
1.5.1 Lost communication between battery modules	11
1.5.2 Lost communication with the higher level system	11
1.6 State of charge	12
1.6.1 Too low SOC	12
1.6.2 Too high SOC	12
2 Replacements	13
2.1 Hot-swapping battery modules	13
2.1.1 Identifying model number	13
2.1.2 Replacing a battery module	13
2.2 Checking fuse	14
2.3 Expanding the ESS	15
2.4 Reducing the ESS	16
3 Formulas for Hot-Swapping	17
4 Block diagram of BMS	22

Chapter 1

Alerts by Status Indicators

The status indicators on the front of a battery module show its operating state.

						Normal
						SOC \geq 75%
						SOC \geq 50%
						SOC \geq 25%
						SOC $<$ 25%
						Voltage imbalance
						Warning
						Fault 1
						Fault 2

Most problems are identified by the red and blue indicators. If a battery module seems to not work properly but its red indicator neither flashes nor comes on solid, check the fuse of the module. See [Checking fuse](#) on page 14.

1.1 Abnormal states

NOTE

Make sure the higher level system is properly configured in accordance with the diagnosis tables in this manual so that it can limit the amount of charge or discharge current in an abnormal state to avoid failure.

There are three levels of alerts:

Warning: When a battery module is likely to become unstable, it goes into a warning state. This state is cleared when the module recovers its normal condition.

Fault 1: When a battery module is likely to become faulty, it goes into a low level fault state, This state may require an appropriate measure to be cleared.

Fault 2: When a battery module falls outside prescribed limits, it goes into a high level fault state. The battery module in this state is not used anymore.

⚠ CAUTION

Battery modules in a fault 2 state require an inspection by LG Chem. Faulty battery modules may be recovered and reused unless the cell voltage is less than 2.0 V. Unrecoverable faulty battery modules must be replaced with new ones immediately. If not replaced immediately, faulty battery modules may decrease the lifespan of the rest battery modules and cause safety problems. Contact LG Chem or your distributor to order new battery modules for replacement.

1.1.1 Fault 1 states

When a battery module goes into a fault 1 state, the red indicator starts flashing and the blue indicators show the fault number in binary form.

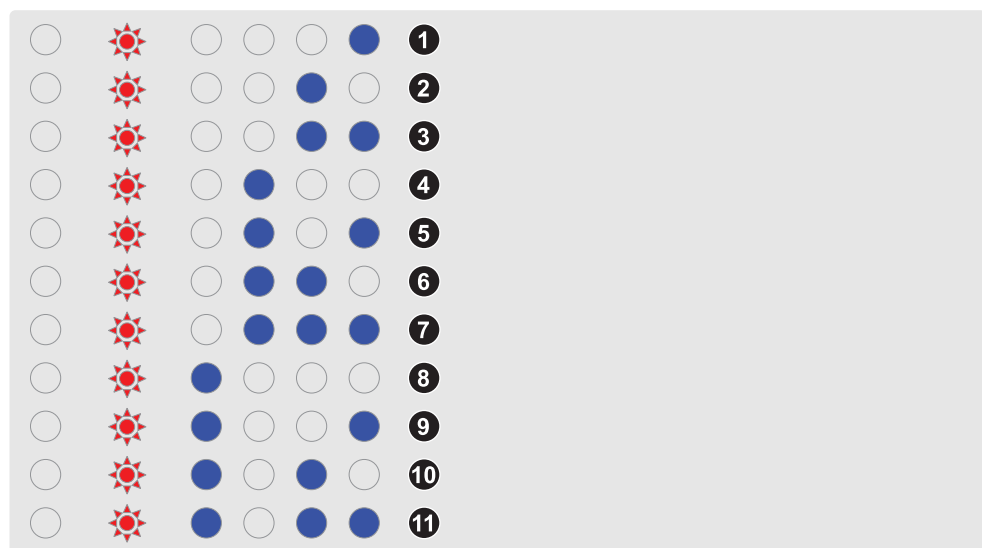

- ① The highest cell voltage is higher than the fault 1 level tolerance limit.
- ② The lowest cell voltage is lower than the fault 1 level tolerance limit.
- ③ A current more than the fault 1 level tolerance limit is charged.
- ④ A current more than the fault 1 level tolerance limit is discharged.
- ⑤ A power more than the fault 1 level tolerance limit is charged.
- ⑥ A power more than the fault 1 level tolerance limit is discharged.
- ⑦ The battery temperature is higher than the fault 1 level tolerance limit.
- ⑧ The battery temperature is lower than the fault 1 level tolerance limit.
- ⑨ The difference between the highest cell voltage and the lowest is larger than the tolerance limit.
- ⑩ The temperature difference inside the battery module is larger than the tolerance limit.
- ⑪ Communication with other battery modules is lost for longer than the fault 1 level tolerance limit.

1.1.2 Fault 2 states

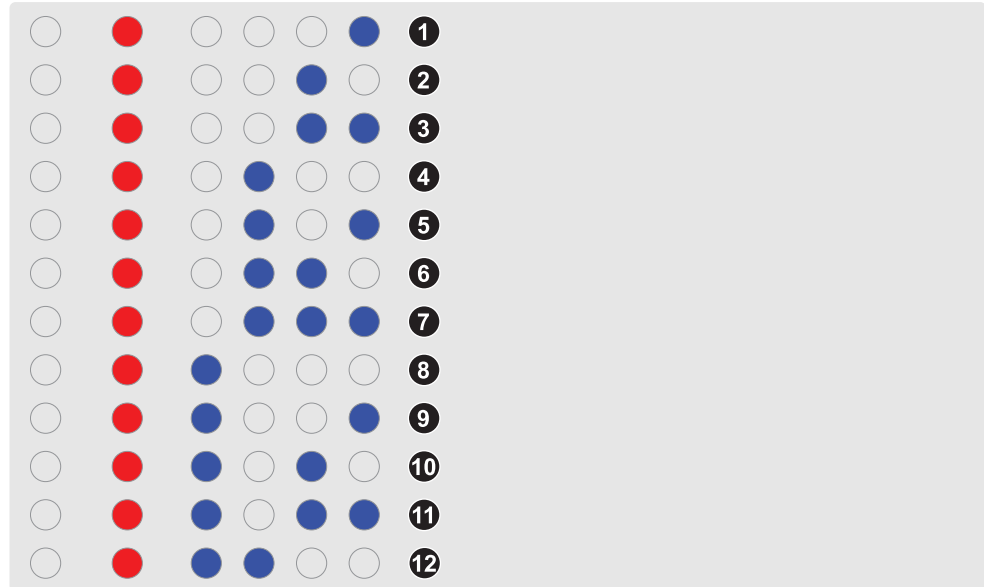

When a battery module goes into a fault 2 state, the red indicator comes on and the blue indicators show the fault number in binary form.



-
- ① The highest cell voltage is higher than the fault 2 level tolerance limit.
 - ② The lowest cell voltage is lower than the fault 2 level tolerance limit.
 - ③ A current more than the fault 2 level tolerance limit is charged.
 - ④ A current more than the fault 2 level tolerance limit is discharged.
 - ⑤ A power more than the fault 2 level tolerance limit is charged.
 - ⑥ A power more than the fault 2 level tolerance limit is discharged.
 - ⑦ The battery temperature is higher than the fault 2 level tolerance limit.
 - ⑧ The battery temperature is lower than the fault 2 level tolerance limit.
 - ⑨ The battery voltage is lower than the tolerance limit.
 - ⑩ The hardware of the BMS is faulty.
 - ⑪ Communication with other battery modules is lost for longer than the fault 2 level tolerance limit.
 - ⑫ Communication with the higher level system is lost for longer than the tolerance limit.
-

1.2 Voltage abnormality

1.2.1 Cell overvoltage



Indicators	Alert Level	Alert condition	Charge limit	Discharge limit	Release condition
 ○ ○ ○ ○ ○	Warning	> 4.25 V for 3 s	0%	100%	< 4.20 V for 3 s
○  ○ ○ ○ ●	Fault 1	> 4.28 V for 3 s	0%	100%	< 4.25 V for 3 s
○  ○ ○ ○ ●	Fault 2	> 4.30 V for 3 s	0%	0%	

The highest cell voltage is higher than the tolerance limit. At the fault 1 state, try these steps:

1. Check the conditions of the battery module using any available method.
2. Manipulate the higher level system to discharge the ESS with a current less than or equal to 63 A until the highest cell voltage is lower than 4.2 V.
3. Re-activate the ESS when the red indicator turns off.

If the problem persists, contact LG Chem for technical assistance.

1.2.2 Cell undervoltage

Indicators	Alert Level	Alert condition	Charge limit	Discharge limit	Release condition
 ○ ○ ○ ○ ○	Warning	< 2.8 V for 3 s	100%	0%	> 3.0 V for 3 s
○  ○ ○ ● ○	Fault 1	< 2.6 V for 3 s	100%	0%	> 2.8 V for 3 s
○  ○ ○ ● ○	Fault 2	< 2.4 V for 3 s	0%	0%	

The lowest cell voltage is lower than the tolerance limit. At the fault 1 state, try these steps:

1. Check the conditions of the battery module using any available method.
2. Manipulate the higher level system to charge the ESS with a current less than or equal to 63 A until the lowest cell voltage is higher than 3 V.
3. Re-activate the ESS when the red indicator turns off. The ESS recharges for 10 minutes before performing a diagnosis after it is activated.

If the problem persists, contact LG Chem for technical assistance.

NOTE

The battery module turns off 10 minutes after going into the fault 2 state.



1.2.3 Too low module voltage

Indicators	Alert Level	Alert condition	Charge limit	Discharge limit	Release condition
○   ○ ○ ●	Fault 2	< 29.0 V for 3 s	0%	0%	

The module voltages is lower than the tolerance limit.

NOTE
The battery module turns off 10 minutes after going into the fault 2 state.

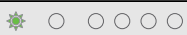
1.2.4 Too large voltage difference between cells

Indicators	Alert Level	Alert condition	Charge limit	Discharge limit	Release condition
	Warning	> 0.3 V for 3 s	50%	50%	< 0.2 V for 3 s
	Fault 1	> 0.5 V for 3 s	0%	0%	< 0.3 V for 3 s



When the lowest cell voltage is higher than 3.5 V, the difference between the highest cell voltage and the lowest cell voltage is larger than the tolerance limit. At the fault 1 state, try these steps:

1. Check the conditions of the battery module using any available method.
2. Shut off the higher level system and wait until cell balancing is completed.
3. Re-activate the ESS when the red indicator turns off.

If the problem persists, contact LG Chem for technical assistance.

1.3 Current abnormality

1.3.1 Over-charged current



Indicators	Alert Level	Alert condition	Charge limit	Discharge limit	Release condition
	Warning	> 68.8 A for 3 s	0%	100%	< 66.1 A for 3 s
	Fault 1	> 71.4 A for 3 s	0%	100%	< 68.8 A for 3 s
	Fault 2	> 74.1 A for 3 s	0%	0%	

A current more than the tolerance limit is charged. At the fault 1 state, try these steps:

1. Check the conditions of the battery module using any available method.
2. Set the maximum charge current to less than 63 A on the higher level system.
3. Re-activate the ESS when the red indicator turns off.

If the problem persists, contact LG Chem for technical assistance.

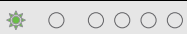
1.3.2 Over-discharged current



Indicators	Alert Level	Alert condition	Charge limit	Discharge limit	Release condition
	Warning	> 68.8 A for 3 s	100%	0%	< 66.1 A for 3 s
	Fault 1	> 71.4 A for 3 s	100%	0%	< 68.8 A for 3 s
	Fault 2	> 74.1 A for 3 s	0%	0%	

A current more than the tolerance limit is discharged. At the fault 1 state, try these steps:

1. Check the conditions of the battery module using any available method.
2. Set the maximum discharge current to less than 63 A on the higher level system.
3. Re-activate the ESS when the red indicator turns off.

If the problem persists, contact LG Chem for technical assistance.



1.3.3 Over-charged power

Indicators	Alert Level	Alert condition	Charge limit	Discharge limit	Release condition
	Warning	> Charge power limit × 110% W for 40 s	0%	100%	< Charge power limit × 0% W or 155.4 W for 3 s
	Fault 1	> Charge power limit × 115% W for 40 s	0%	100%	< Charge power limit × 0% W or 155.4 W for 3 s
	Fault 2	> Charge power limit × 120% W for 40 s	0%	0%	

A power more than the tolerance limit is charged. Only with the residential models including EM048063P3S2 and EM048126P3S7, at the fault 1 state, try these steps:

1. Check the conditions of the battery module using any available method.
2. Make sure that the higher level system is properly configured not to exceed the maximum charge power of the battery module.

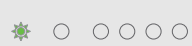
1.3.4 Over-discharged power



Indicators	Alert Level	Alert condition	Charge limit	Discharge limit	Release condition
	Warning	> Discharge power limit × 110% W for 40 s	0%	100%	Discharge power limit × 0% W or 155.4 W for 3 s
	Fault 1	> Discharge power limit × 115% W for 40 s	0%	100%	Discharge power limit × 0% W or 155.4 W for 3 s
	Fault 2	> Discharge power limit × 120% W for 40 s	0%	0%	

A power more than the tolerance limit is discharged. Only with the residential models including EM048063P3S2 and EM048126P3S7, at the fault 1 state, try these steps:

1. Check the conditions of the battery module using any available method.
2. Make sure that the higher level system is properly configured not to exceed the maximum discharge power of the battery module.

1.4 Temperature abnormality

1.4.1 Too high battery temperature



Indicators	Alert Level	Alert condition	Charge limit	Discharge limit	Release condition
 ○ ○ ○ ○ ○	Warning	> 50.0°C for 3 s	50%	50%	< 48.0°C for 3 s
○  ○ ● ● ●	Fault 1	> 55.0°C for 3 s	0%	0%	< 50.0°C for 3 s
○  ○ ● ● ●	Fault 2	> 60.0°C for 3 s	0%	0%	

The battery temperature is higher than the tolerance limit. At the fault 1 state, try these steps:

1. Check the conditions of the battery module using any available method.
2. Check the ambient temperature.
3. Run the air conditioner until the ambient temperature drops below 30°C.
4. Deactivate the ESS and wait for 2 hours until the battery module cools down.
5. Re-activate the ESS.

If the problem persists, contact LG Chem for technical assistance.

1.4.2 Too low battery temperature

Indicators	Alert Level	Alert condition	Charge limit	Discharge limit	Release condition
 ○ ○ ○ ○ ○	Warning	< -12.0°C for 3 s	50%	50%	> -10.0°C for 3 s
○  ● ○ ○ ○ ○	Fault 1	< -15.0°C for 3 s	0%	0%	> -12.0°C for 3 s
○  ● ○ ○ ○ ○	Fault 2	< -20.0°C for 3 s	0%	0%	

The battery temperature is lower than the tolerance limit. At the fault 1 state, try these steps:

1. Check the conditions of the battery module using any available method.
2. Check the ambient temperature.
3. Run the air conditioner until the ambient temperature rises above 18°C.
4. Deactivate the ESS and wait for 2 hours until the battery module warms up.
5. Re-activate the ESS.

If the problem persists, contact LG Chem for technical assistance.

1.4.3 Too large temperature difference inside battery module

Indicators	Alert Level	Alert condition	Charge limit	Discharge limit	Release condition
○  ● ○ ● ○	Fault 1	> 10.0°C for 3603 s	0%	0%	< 5.0°C for 3 s

The temperature difference inside the battery module is larger than the tolerance limit. At the fault 1 state, try these steps:

1. Check the conditions of the battery module using any available method.
2. Make sure that no heating or cooling source is nearby.
3. Deactivate the ESS and wait for around 2 hours until the temperature difference is reduced to less than 5°C.
4. Re-activate the ESS.

If the problem persists, contact LG Chem for technical assistance.

1.5 Lost communication

1.5.1 Lost communication between battery modules

Indicators	Alert Level	Alert condition	Charge limit	Discharge limit	Release condition
○ ✖ ● ○ ● ●	Fault 1	Lost communication for 10 s	0%	0%	Resumed for 1 s
○ ● ● ○ ● ●	Fault 2	Lost communication for 50 s	0%	0%	

Communication with other battery modules is lost for longer than the tolerance limit.

1. Check the conditions of the battery module using any available method.
2. Deactivate the ESS.
3. Make sure that the intra-rack communication cables are properly connected between the battery modules.
4. Re-activate the ESS.

1.5.2 Lost communication with the higher level system

Indicators	Alert Level	Alert condition	Charge limit	Discharge limit	Release condition
○ ● ● ○ ○	Fault 2	Lost communication for 610 s	0%	0%	

Communication with the higher level system is lost for longer than the tolerance limit.

1. Check the conditions of the battery module using any available method.
2. Deactivate the ESS.
3. Make sure that the higher level communication cable is properly connected between the master module and the higher level system.
4. Re-activate the ESS.

1.6 State of charge

1.6.1 Too low SOC

Indicators	Alert Level	Alert condition	Charge limit	Discharge limit	Release condition
 ○ ○ ○ ○ ●	Warning	< 2.0% for 10 s	100%	50%	> 3.0% for 10 s

The SOC is lower than the tolerance limit.

1. Check the blue indicators to see the SOC.
2. Manipulate the higher level system to charge the ESS with a current less than or equal to 63 A until the SOC is higher than or equal to 3%.

1.6.2 Too high SOC

Indicators	Alert Level	Alert condition	Charge limit	Discharge limit	Release condition
 ○ ● ● ● ●	Warning	> 99.0% for 10 s	50%	100%	< 98.0% for 10 s

The SOC is higher than the tolerance limit.

1. Check the blue indicators to see the SOC.
2. Manipulate the higher level system to discharge the ESS with a current less than or equal to 63 A until the SOC is lower than or equal to 98%.

Chapter 2

Replacements

2.1 Hot-swapping battery modules

2.1.1 Identifying model number

To ensure that a new battery module is the same model as the old ones, verify the new module's model number.

1. Press the On/Off button on the new battery module to activate it. The green indicator turns on first and then the rightmost blue indicator turns on a few seconds later.
2. Press and hold the On/Off button for longer than 5 seconds. While the button is pressed, the blue indicators show the last digit of the model number in binary form.

<input type="radio"/>	<input type="radio"/>	<input type="radio"/>	<input type="radio"/>	<input type="radio"/>	<input checked="" type="radio"/>	EM048063P3S 1
<input type="radio"/>	<input type="radio"/>	<input type="radio"/>	<input type="radio"/>	<input checked="" type="radio"/>	<input type="radio"/>	EM048063P3S 2
<input type="radio"/>	<input type="radio"/>	<input type="radio"/>	<input checked="" type="radio"/>	<input type="radio"/>	<input type="radio"/>	EM048063P3S 4
<input type="radio"/>	<input type="radio"/>	<input type="radio"/>	<input checked="" type="radio"/>	<input type="radio"/>	<input checked="" type="radio"/>	EM048063P3S 5
<input type="radio"/>	<input type="radio"/>	<input type="radio"/>	<input checked="" type="radio"/>	<input checked="" type="radio"/>	<input type="radio"/>	EM048126P3S 6
<input type="radio"/>	<input type="radio"/>	<input type="radio"/>	<input checked="" type="radio"/>	<input checked="" type="radio"/>	<input checked="" type="radio"/>	EM048126P3S 7
<input type="radio"/>	<input type="radio"/>	<input checked="" type="radio"/>	<input type="radio"/>	<input type="radio"/>	<input type="radio"/>	EM048126P3S 8

2.1.2 Replacing a battery module

NOTE

Hot-swapping is permitted only with EM048063P3S1 and EM048126P3S6 models.

Replace a faulty battery module only when less than 1 A of current flows into or out of it. This indicates that the battery module is neither charging nor discharging.

To replace a battery module, follow these steps:

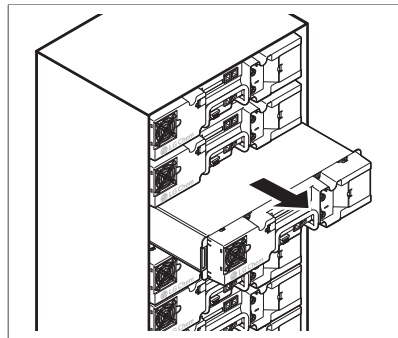
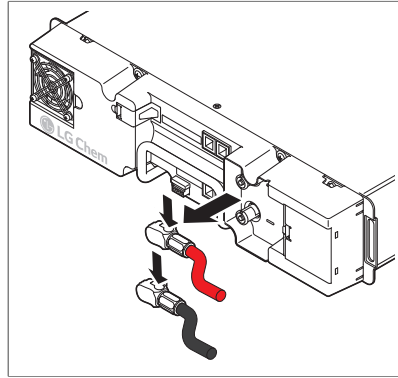

1. Holding the button on the connector of the positive cable, pull out the connector to remove the cable from the module. Remove the negative cable using the same method.
2. Press the On/Off button on the module to deactivate it.
3. Remove the communication cables from the module.
4. Loosen the screws at the brackets on both sides of the module to remove the module from the rack.
5. Replace the module with a new one and fasten the brackets.
6. Connect the communication cables to the new module.
7. Press the On/Off button on the module to activate it. If some of the blue indicators flash, the module is the wrong model. See **Identifying model number** on page 13.
8. Connect the power cables to the module.

⚠ CAUTION

Do not replace two or more battery modules simultaneously. Replace modules one by one, repeating this replacement procedure.

2.2 Checking fuse

To check and replace the fuse of a battery module, follow these steps:

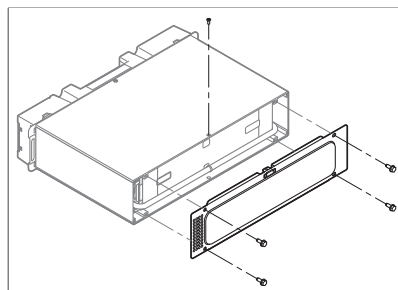

1. Loosen the M4 screw at the top center of the rear of the battery module.
2. Loosen the four M6 screws at each corner of the rear.
3. Remove the back panel.

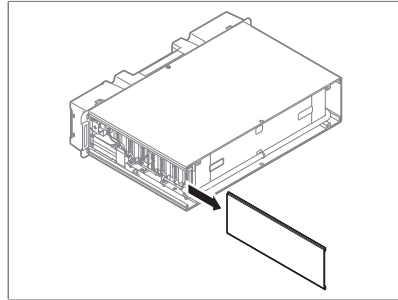

4. Slide the right panel to the back to remove it.

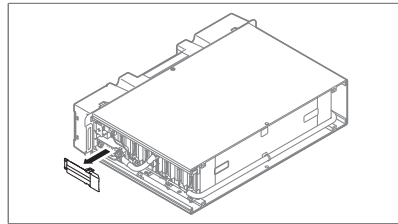

5. Remove the fuse cover by pulling it out.

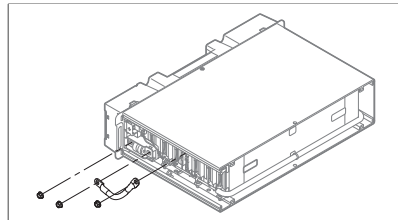

6. Loosen the three nuts that secure the fuse and the negative cable.

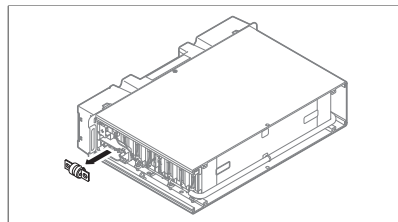

7. Pull out the fuse.

8. Measure the resistance of the fuse to see if it is blown.

9. If the fuse is blown, insert a new fuse into the fuse holder.

10. Reassemble in the reverse order of the disassembly procedure.

2.3 Expanding the ESS

To expand the ESS by adding more battery modules, follow these steps:

1. Press and hold the On/Off button on the master module for longer than 5 seconds to deactivate the ESS.
2. Shut off the higher level system.
3. Install new battery modules in the rack.
4. Re-activate the ESS.

CAUTION

Never fail to keep this sequence unchanged.

2.4 Reducing the ESS

To reduce the ESS by removing some battery modules, follow these steps:

1. Press and hold the On/Off button on the master module for longer than 5 seconds to deactivate the ESS.
2. Shut off the higher level system.
3. Remove the unwanted battery modules.
4. Re-activate the ESS.

 **CAUTION**

Never fail to keep this sequence unchanged.

Chapter 3

Formulas for Hot-Swapping

One battery module can accommodate up to 63 A. If the amount of current that each of the remaining modules has to accommodate exceeds 63 A, hot-swapping is not allowed. The following formula calculates the maximum current per module that allows hot-swapping.

The maximum current that allows hot-swapping
= the higher-level system's current ÷ (the number of modules installed – the number of faulty modules that should be replaced)

For example, if two modules are faulty and the higher-level system's current is 120 A when six modules are installed, the maximum current during hot-swapping is 30 A.

$$120 \text{ A} \div (6 - 2) \\ = 30 \text{ A}$$

Use the following formula to determine how many faulty modules can be replaced at a time.

The number of hot-swappable modules
= the number of modules installed – (the higher-level system's current ÷ 63 A)

All the decimal places should be removed from the result without rounding. For example, if two modules are installed and the higher-level system's current is 70 A, no modules can be replaced.

$$2 - (70 \text{ A} \div 63 \text{ A}) \\ = 0.89 = 0$$

If four modules are installed and the higher-level system's current is 80 A, two faulty modules can be replaced at a time.

$$4 - (80 \text{ A} \div 63 \text{ A}) \\ = 2.73 = 2$$

Use the following tables for quick reference when hot-swapping faulty battery modules.

In case of 2 battery modules

Higher-level system current (A)	The maximum current during hot-swapping (A)	The number of replaceable modules
55	55	1
60	60	1
65	65	0

In case of 4 battery modules

Higher-level system current (A)	The maximum current during hot-swapping (A)	The number of replaceable modules
60	60	3
70	35	2
80	40	2
90	45	2
100	50	2
110	55	2
120	60	2
130	43.3	1
140	46.7	1
150	50	1
160	53.3	1
170	56.7	1
180	60	1
190	63.3	0

In case of 6 battery modules

Higher-level system current (A)	The maximum current during hot-swapping (A)	The number of replaceable modules
60	60	5
70	35	4
80	40	4
90	45	4
100	50	4
110	55	4
120	60	4
130	43.3	3
140	56.7	3
150	50	3
160	53.3	3
170	56.7	3
180	60	3
190	47.5	2
210	52.5	2

220	55	2
230	57.5	2
240	60	2
250	62.5	2
260	52	1
270	54	1
280	56	1
290	58	1
300	60	1
310	62	1
320	64	0

In case of 8 battery modules

Higher-level system current (A)	The maximum current during hot-swapping (A)	The number of replaceable modules
60	60	7
70	35	6
80	40	6
90	45	6
100	50	6
110	55	6
120	60	6
130	43.3	5
140	46.7	5
150	50	5
160	53.3	5
170	56.7	5
180	60	5
190	47.5	4
200	50	4
210	52.5	4
220	55	4
230	57.5	4
240	60	4
250	62.5	4
260	52	3
270	54	3
280	56	3
290	58	3
300	60	3
310	62	3
320	53.3	2
330	55	2
340	56.7	2
350	58.3	2
360	60	2

370	61.7	2
380	54.3	1
390	55.7	1
400	57.1	1
410	58.6	1
420	60	1
430	61.4	1
440	62.9	1
450	64.3	0

In case of 10 battery modules

Higher-level system current (A)	The maximum current during hot-swapping (A)	The number of replaceable modules
60	60	9
70	35	8
80	40	8
90	45	8
100	50	8
110	55	8
120	60	8
130	43.3	7
140	46.7	7
150	50	7
160	53.3	7
170	56.7	7
180	60	7
190	47.5	6
200	50	6
210	52.5	6
220	55	6
230	57.5	6
240	60	6
250	62.5	6
260	52	5
270	54	5
280	56	5
290	58	5
300	60	5
310	62	5
320	53.3	4
330	55	4
340	56.7	4
350	58.3	5
360	60	4
370	61.7	4
380	54.3	3

390	55.7	3
400	57.1	3
410	58.6	3
420	60	3
430	61.4	3
440	62.9	3
450	56.3	2
460	57.5	2
470	58.8	2
480	60	2
490	61.3	2
500	62.5	2
510	56.7	1
520	57.8	1
530	58.9	1
540	60	1
550	61.1	1
560	62.2	1
570	63.3	0

Chapter 4

Block diagram of BMS

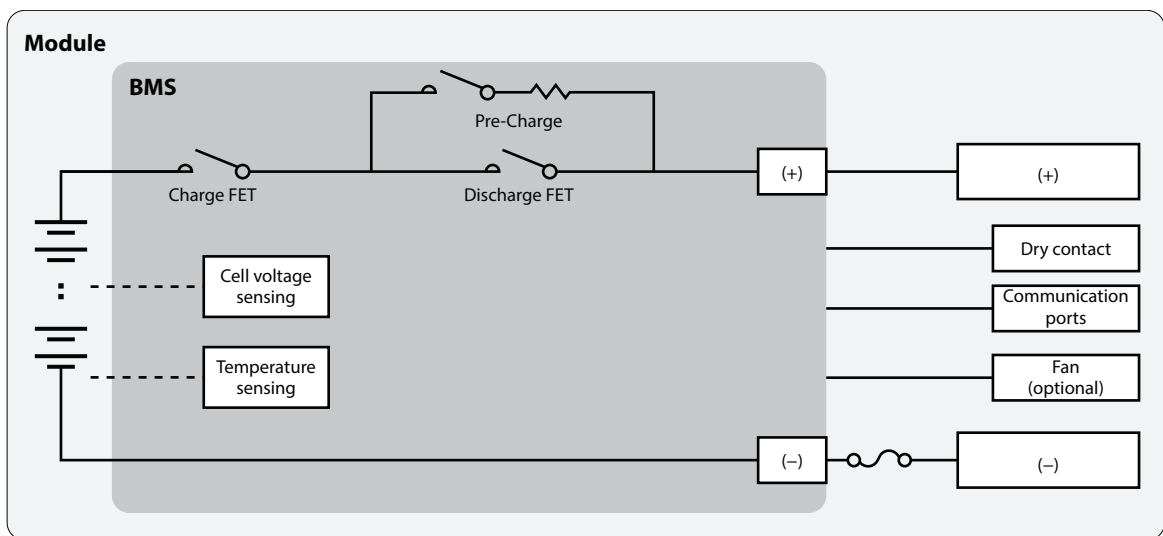

The pre-charge circuit operates to avoid inrush current with these models:

- EM048063P3S2
- EM048063P3S4
- EM048063P3S5
- EM048126P3S7
- EM048126P3S8

The discharge path is capable of withstanding 70 W with the resistance of 60 Ω .



Keep this manual for later use.

© 2017 LG Chem
LG Twin Towers, 128 Yeoui-daero Yeongdeungpo-gu Seoul
07336, Korea